

Access for All

A design guide to specifying doors and hardware for universal access

Access for All

This Guide provides a concise summary of the essential aspects of accessibility in relation to doors and their associated hardware. It supercedes the Architectural Hardware Design Guide first published in 2004.

To provide guidance on the selection of the most appropriate products, typical examples, sourced from the Ingersoll Rand Security Technologies product portfolio, are shown in the blue tinted boxes throughout the Design Guide.

About Ingersoll Rand

Ingersoll Rand Security Technologies is an integral part of the Ingersoll Rand Corporation - a diversified industrial concern with annual operating revenues in excess of US \$11 billion - and is proud of its association with many leading architects, designers, contractors and other construction professionals throughout the world.

This document has been compiled under the auspices of the widely accredited RIBA CPD scheme and - being both a RIBA CPD provider and RIBA Manufacturers Network member - further supports our aim of providing authoritative advice in a holistic, best practice approach to the demands of modern construction.

About this Design Guide

We recognise the need for clear advice and innovative solutions to help service providers fulfil their duties under the Disability Discrimination Act (DDA).

Interpreting the design requirements contained within Building Regulations Approved Document M (2004) and British Standards Code of Practice, BS8300 is, for many, a daunting prospect. As a global manufacturer and supplier of construction products directly impacted by this all-pervading legislation, Ingersoll Rand Security Technologies are able to offer specification insight without peer in our sector.

An expansive portfolio and expertise in openings and related hardware allows us to demystify many issues and provide our customers and specifier client base with the highest level of confidence.

This Design Guide was commissioned by Ingersoll Rand Security Technologies, written by Mike Finbow BA(Arch), NBA Tectonics and was designed by Ranshaw Mills Associates.

An electronic version of this document is available, in addition to a large format version, on our website at www.securitytechnologies.ingersollrand.co.uk

Contents

The Disability Discrimination Act	page 1
Building Regulations	page 2
BS 8300 and Related documents	page 3 - 4
Door Controls	
- Requirements	page 5 - 6
- Product selection	page 7
- Powered doors	page 8 - 9
- Low Energy	page 10 - 11
- Opening & Closing forces	page 12
- Mechanical & Electromagnetic	page 13
Door operating furniture	
- Lever handles	page 14 - 15
- LRV & Relative Temperature	page 14 - 15
Locks & latches	page 16
Final exit hardware	page 17

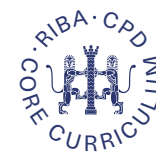

The Disability Discrimination Act

What is the DDA?



The Disability Discrimination Act - 1995

The first thing to emphasise is that the DDA is civil rights legislation concerning discrimination; not the design and construction of buildings, per se.

Since it is not possible to pre-empt a legal challenge in any particular case, it is not correct to state that building works nor indeed any building products are *DDA-compliant*.

Suitably designed buildings and building products can only assist people in meeting their duties under the DDA.

There are two particularly relevant parts to the DDA - Part II, relating to employment and Part III, concerning the provision of goods, services and premises.

As an Act passed by the UK Parliament, the DDA applies, and has the force of law, throughout the UK.

Since October 1st 2004, any one of the 9.8 million* people in the UK identified as having a disability now have legal recourse to challenge discrimination related to service provision. This is in addition to the rights established under Part II - Employment Provision.



Additional duties are placed on public bodies, such as councils, to actively promote disability awareness and solutions. In 2005, the scope of the DDA was extended to cover additional conditions such as Multiple Sclerosis, Cancer and HIV/AIDS. Previous exemptions for certain modes of transportation and private clubs (of 25 or more members) were also removed.

* Source - Office of the Deputy Prime Minister (ODPM) 2004

Part II - Employment duties

Duties to avoid discrimination in employment have been in place since 1996. The exemption from having to alter a physical feature if it met the guidance in the respective ADM when it was constructed could only be claimed up to 30 September 2004. Since this exemption no longer applies any alterations required to meet the needs of an individual employee must satisfy the current Part M.

Part III - Duties for Service Providers

Service Providers are people or organisations that provide goods, services or premises direct to the general public - or a section of it - even if they are free of charge.

Examples of organisations providing services covered by the Act include, but are not limited to:

- Government departments, local authorities and charitable trusts
- Hotels, restaurants and public houses
- Banks, post offices and building societies
- Sports and leisure centres
- Courts, hospitals and clinics

Note: for educational establishments refer to SENDA (page 4)

Part III of the DDA 1995 makes it unlawful for Service Providers to **discriminate against disabled people for reasons pertaining to their disability, unless it can be justified**. This duty is neglected if Service Providers fail to make *reasonable adjustments* to facilitate use of the service. Justification on economic grounds may be allowable but the courts are likely to hold a different view on a sole proprietor of a small shop to that of a national store chain with greater resources.

Reasonable adjustments

What is meant by *making reasonable adjustments*?

Some adjustments relate to the way in which the service is provided and are generally the responsibility of management, for example:

- Changing a practice, policy or procedure
- Providing an auxiliary aid (e.g. an audio tape) or service
- Providing a reasonable, alternative method of making the service available, where the presence of a *physical feature* makes it impossible (or unreasonably difficult) to provide *direct* access to the service

What is a *physical feature*?

A *physical feature* includes:

- any feature arising from the design or construction of the building - such as a doorway - including the approach or access into it
- any fixture, fitting, furniture, equipment or materials in, or brought into, the building
- Since October 1st, 2004 - where it is not possible to provide the service in an alternative way - there is a duty to overcome the *physical feature* by:
 - a. Removing it (e.g. re-positioning a cabinet)
 - b. Altering it (e.g. widening a doorway or improving the door operating device)
 - c. Avoiding it (e.g. providing an alternative access route or method)

Approved Document M - 2004 edition



ISBN 0-10-545095-2

The 2004 edition of **Approved Document M (ADM 04) of the Building Regulations for England and Wales** became effective May 1st, 2004.

Entitled '**Access to and use of buildings**', it differs from the 1999 edition in that it takes a more *inclusive* approach to access; not focusing solely on the needs of disabled people but also acknowledging that access can be difficult for the population at large e.g. for parents with children and for people carrying luggage.

ADM sets out specific criteria, such as *Newtons* for door opening forces and *LRV points* for visual contrast, it also

recommends possible solutions which, if employed, would be deemed to satisfy Part M.

The sections that have been updated in this edition are concerned with non-domestic buildings; the sections on dwellings (6 to 10) having been reproduced exactly as in the 1999 edition.

Building (Scotland) Regulations 2004

Technical Handbooks are provided to assist specifiers in meeting these regulations, similar to the way in which ADM advises on satisfying Part M. The topic of accessibility however is not as comprehensively, nor as neatly, encompassed in a single document. Even though Section 4 (Safety) does include generic spatial information, it offers virtually no guidance in the field of architectural hardware specification. It states, "*Those with a duty under the DDA should be aware that their responsibility to observe 'good practice' extends beyond matters covered by The Building Regulations.*"

Designers are simply referred to BS 8300 for guidance with the comment, "*This document also provides guidance on matters not covered within the remit of the building regulations.*"

Building Regulations (Northern Ireland) 2000 (Amended)

The amended Technical Booklet (Part R), published by The Department of Finance and Personnel, became effective in November 2006. It adopts the title, single-source format and general layout of ADM but, in common with the Scottish Regulations, offers no detailed guidance relating to door hardware; it does however include dimensional details for handrailing, rails and sanitary fittings for accessible WCs and bathrooms.

Where Part M applies

Part M applies not only to new developments and extensions but also to material alterations of existing buildings and changes of use to, for example, hotels, institutions, public buildings and shops.

Purpose-built student accommodation is treated as if it were a hotel and is therefore subject to the non-domestic provisions of Part M and specific guidance for schools, particularly on staircases, is now included in the revised ADM.

The revised Part M applies to all developments whose plans were not fully passed by a Building Control body before May 1st, 2004.

Overall requirements of Part M

As with all parts of the Building Regulations, the main requirements are performance-based; the guidance in the Approved Document being just one way of satisfying those requirements. You are at liberty to propose other - perhaps innovative - solutions provided you can show that they achieve at least the same level of performance.

Part M1 of the revised Regulations requires that "reasonable provision shall be made for people to (a) gain access to, and (b) use, the building and its facilities". However, it is noted that this requirement does not apply to parts of a building whose primary use is to enable services or fittings to be inspected, repaired or maintained.

M2 provides for suitable independent access to extensions, where reasonably practicable, except where there is suitable access to the extension through the existing building.

M3 is concerned with sanitary accommodation. It ensures that, when a non-domestic building is extended, reasonable provision is made for sanitary accommodation for use by people both in the extension and the existing building.

M4 concerns sanitary accommodation in dwellings and is a repeat of M3 in the 1999 edition.

BS 8300

BS 8300



BS 8300: 2001, “Design of buildings and their approaches to meet the needs of disabled people – Code of practice”, published in October 2001, provides guidance on good practice in the design of buildings so that they are convenient for use by disabled people.

Many of the recommendations are based on the results of desk studies and ergonomic trials. Where no validated research was available, recommendations were drawn from accepted good practice.

Amendment No.1: 2005

This publication combines both new research and a realignment of existing best practice, bestowing BS 8300 with even greater importance as a guidance document. Although it now more closely reflects ADM requirements, there are still some areas of divergence that may trip the unwary specifier. Door Opening Force and Light Reflectance Values are two such topics which are extensively aired in this guide.

In an attempt to reconcile these two sources of guidance, the ODPM* released the following statement:

“Where the recommendation in BS 8300 implies a higher standard than that recommended in ADM, clearly that would be acceptable. Also, where the BS recommendations post-date the publication of ADM and are based on new or re-evaluated research ... those recommendations too may be considered acceptable alternatives to the guidance in ADM.”

It is assumed that interested parties, such as Building Control Officers and specifiers, will begin to adopt the more recent BS 8300 guidance, so this is reflected in our general commentary.

* ODPM was retitled ‘Communities and Local Government’ (CLG) in 2006, although references to it are retained in this guide for historical accuracy.

The relationship: DDA, Part M & BS 8300

In seeking to fulfil obligations under the DDA Part III, any material alterations must also satisfy Part M and, as such, the guidance in ADM will be the first point of reference. ADM however is not exhaustive and best practice guidance has been updated since its publication in 2004. When detailed advice is required, such as the recommended dimensions for lever door furniture, other reference documents will need to be consulted; BS 8300 being the foremost among them.

Exemptions under the DDA

There are limited situations where demonstration of compliance with guidance published in the 1992 or 1999 editions of the Approved Document can give certain exemptions from making adjustments in respect of the DDA.

For existing buildings, where a *physical feature* was constructed in accordance with the technical guidance described in previous editions of ADM (i.e. 1992 or 1999), there is no obligation to alter that *physical feature* if less than 10 years has passed from the date it was constructed. This is providing the *physical feature* continues to satisfy that original guidance.

The relationship: DDA, Part M & BS 8300

N.B. This exemption only applies to those aspects that were covered in the previous editions of ADM. Exemption could, for example, be claimed for the width of a door opening (as effective clear width requirements are included in the previous editions) but issues relating to door opening furniture, door opening forces or visual contrast will not be granted exemption.

Access Statements

An *Access Statement* is a document produced after due consideration of access requirements including, usually, the undertaking of an *Access Audit*. It is intended to accompany all plan submissions; firstly at the planning stage and then when seeking Building Control approval.

Although not mandatory, it is seen as a vital document that will:

- set out the designers’ strategy for providing reasonable access
- confirm that the design follows the guidance in ADM or describe in which respects alternative solutions are proposed
- give details of the expert advice obtained and / or any new research carried out in support of any proposed, alternative solution
- include all the information needed by planning or building control bodies when considering an application; thus encouraging a faster response

The *Access Statement* is thought to be particularly relevant to *heritage buildings*, where there are likely to be more constraints on the full application of the guidance in ADM. Similarly, there may be hazardous areas within a large industrial plant where full independent access would present unacceptable risks to some, such as elderly people or children.

In the event of a civil action being brought under the DDA it is likely that the *Access Statement* will be called upon in support of the arguments for deviation from ADM or other accepted guidance. It is important therefore that the reasoning bears scrutiny, as ill-founded or frivolous arguments are likely to fail any test of *reasonableness*.

Further guidance on *Access Statements* is available from the Disability Rights Commission (www.drc-gb.org).

The Centre for Accessible Environments (CAE) has also published the *Access Audit Handbook* in conjunction with RIBA Publishing.

Ultimately the duty lies with the person/s providing the service. If, however, you are responsible for advising a client on the design of a building or, say, a facilities manager responsible for the fabric of a building, you will need to be aware of the issues concerning its use by disabled people in order to give sound advice.

HTM 58 and 59



HTM 59 : 2005 – IRONMONGERY

The current NHS guidance on architectural hardware (or ironmongery) for healthcare environments.

HTM 59 offers general specification advice but with particular stress on the suitability for high frequency applications i.e. function, performance, durability, fixing and maintenance regimes. The case for robust product solutions (which implies a demand for longer life-cycles and the attendant reduction in whole life costs) is also promoted.

Although it lists all applicable British and European product standards there is only a cursory mention of the DDA; whereas BS8300 and Approved Document M (ADM) are not referenced at all. This presumes healthcare professionals are well versed in these overarching documents - which effectively supersede Health Facilities Notes 'HFN 14 Disability Access' - and will resort to them to derive further, detailed guidance on important issues such as maximum door opening forces.

HTM 58 : 2005 – INTERNAL DOORSETS

Intrinsically linked to the above, HTM 58 places great emphasis on the use of doorsets and guidance is given on many aspects such as size, configuration, strength and durability; smoke, fire and acoustic properties as well as specific accessibility issues such as visibility, colour and contrast. Both security and hygiene also feature highly, in deference to the public's ongoing concerns in both areas.

Both documents serve to support the Department of Health's stated argument that "...high performance standards required of door leaves, frames and ironmongery in health buildings can best be met when these components are accurately fitted and matched in the factory and delivered to site as a complete unit"

SENDA



SENDA (Special Educational Needs and Disability Act 2001) amends Part IV of the DDA to establish legal rights for existing and potential pupils and students with disabilities. Although Part III of the DDA specifically excludes educational services from the provisions relating to goods, facilities and services, it *does* cover *non-educational* services carried out from an educational building i.e. using school premises as a Polling Station.

Like the DDA Part III, the duties for education were introduced in stages. Most of the Act was implemented on September 1st, 2002; the duty to provide auxiliary aids a year later and the requirement to alter *physical features* came into force in September 2005. The effect on the design and construction of educational buildings is now similar to that for buildings where services are provided to the general public.

Performance doorsets

The call for extended life-cycles and sustained performance in construction products is neatly answered through the rise in specification of performance doorsets.

They offer a compelling argument for the build process. A single, accountable source (offering the in-frame precision that only off-site manufacture can provide) ensures predictable, rapid site installation and virtually zero snagging to help meet strict construction schedules. Doors are often required to perform multiple roles - fire and smoke protection, privacy provision, energy conservation, acoustic reduction and, of course, varying levels of security.

On top of all this, they need to be accessible.

Steel performance doorsets, in particular, not only offer the end user enhanced performance and longevity but provide, often over-looked, advantages that directly improve accessibility.

Weight - contrary to popular belief steel door leaves weigh less than their timber counterparts (1 hour fire-resisting steel door @ 28Kg/m² compared with timber @ 35Kg/m² or 45Kg/m² for 2 hour). This reduces the inertia or 'dead weight' which must be overcome when opening a door.

Size - with the drive for greater opening widths, steel doors are better placed, due to their innate strength and rigidity, to cope with the extra loads and impact stresses encountered over the lifetime of the building.

Finish - when considering the demands for acceptable *visual contrast* with door hardware and surrounding surfaces, durable paint finishes offer greater scope to the designer. However, if a wood effect is non-negotiable, some steel doors can be coloured and imprinted with a grain which closely replicates many popular wood veneers.



Door controls - Requirements

Objectives for door operation

The objective in an inclusive environment is for all people, irrespective of age, gender or disability, to have independent access; not only into buildings but also to the rooms and spaces within them. At the same time there are situations, such as in case of fire, when it is essential that doors close effectively.

Ergonomic research

During the development of BS 8300, ergonomic research was carried out to determine the capabilities of disabled people in opening doors against the resistance of door closers. Partly as a result of this work, the *maximum* force which should be required to open a door was stated in ADM as 20 Newtons, the S.I. unit of force.

The implications on door controls

To understand the implications of the guidance offered in ADM and BS 8300 it is important to recognise that the application of the door is critical. The requirements will vary, for example, according to whether the door is an internal or external door, a fire door or non-fire door. The following sections give specific guidance for such variations.

A simple, inexpensive door force gauge can be used to test existing openings against accessibility guidelines (see "Opening forces" on page 12).



External doors

External entrance doors, particularly those to buildings used by the general public, need to be convenient for a wide variety of users, e.g. parents with children in push-chairs, elderly people and wheelchair users. In addition, swing doors need to be able to resist wind forces. In these circumstances, doors with conventional closers are likely to make access difficult for the majority of users. Consequently, there is a general preference for a powered door solution.

ADM - 2.13 states: "Doors to accessible entrances will satisfy Requirement M1 or M2 if :

- a. where required to be self-closing, a power operated door opening and closing system is used when, through calculation and experience, it appears that it will not be possible otherwise for a person to open the door using a force no greater than 20N at the leading edge"

BS 8300 - 6.3.2 states: " Where, in order to meet the opening force limits, the door closing device is insufficient to keep an entrance door closed against external conditions, consideration should be given to installing one of the following door closing systems:

- a. a power operated (automatic) door;
- b. a low energy swing door;
- c. a power operated revolving door assembly;
- d. an entrance lobby or air lock system of inner and outer doors"



Internal doors

Internal doors are principally specified and provided for :

- Fire and smoke control
- Privacy
- Acoustic, environmental and energy control

Each application has specific characteristics and therefore specific requirements which must be addressed by the specifier. Fire-resisting doors, for example, are subjected to far more demanding criteria than non-fire doors.

Fire and smoke control doors

Doors which are designated as fire and smoke control doors are subject to very different, and seemingly opposing, requirements which govern ease of access and the positive closing of a door in the event of a fire.

ADM still actually states 20N as the maximum opening force. BS 8300, as amended, contains a more complicated *Two Phase* opening force rule, based on a maximum initial force of 30N (see BS 8300 7.3.1 on page 12). These variances are retained in the official ADM and BS 8300 extracts quoted in this guide.

BS 8300 - 7.3.2 commentary: *"Poorly specified controlled door closing devices can make doors virtually impassable to some disabled people. Self closing fire doors are more likely to be rendered ineffective by the occupants of a building if the doors are regarded as an impediment to access."*

EN 1154 is the European performance standard which supports the CE marking requirement for door closers suitable for fire doors. It indicates that a fire door must be held shut by a door closer with a minimum force of 18Nm, equivalent to power size 3. This force, exerted on the door in order to close and hold it shut in the event of fire, is such that the corresponding opening force is likely to be much greater than the prescribed limits. In these situations ADM recommends the use of electromagnetic or low-energy door controls.

ADM - 3.10 states: "Internal doors will satisfy Requirement M1 or M2 if:

- k. fire doors, particularly those in corridors, are held open with an electro-magnetic device, but self-close when:
 - activated by smoke detectors linked to the door individually, or to a main fire / smoke alarm system;
 - the power supply fails (when) activated by a hand operated switch"

Note: Fire Authorities will always recommend using detectors which are 'hard wired' to an Automatic Fire Detection (AFD) system.

BS 8300 also supports this solution. *"Where the force required to open a fire door on a circulation route exceeds the limits described in 7.3.1, an electrically powered hold open device ... which conforms to the requirements of (BS) EN 1155 should be installed."*

So for cross-corridor fire doors, the most satisfactory solution is to use electromagnetic hold open devices to retain the doors in the open position and provide the required clearance (see Briton 2130B.TE on page 13).

For doors into individual rooms - which may be required to be closed for privacy, acoustic control or draught prevention - an electromagnetic *free-swing* device is preferable (see Briton 996 on page 13).

In both cases the closing function is activated by one of the events described in ADM Clause 3.10 above.

Non-Fire doors

All non-fire doors need to be fully accessible by wheelchair users. An exception is made only for room doors - such as in hotels - where an equivalent wheelchair accessible room is available for independent use.

For non-fire doors to be able to self-close and still meet the newer 30N initial opening force criterion of BS 8300, it is necessary to use a high efficiency, variable power closer adjusted to the lowest strength setting (power size 1). At this setting the closing force is much reduced and even the resistance of a latch can be an issue. Locks with a *soft-action* latch will help to ensure that the door closes into the frame correctly (see Briton 5500 Series on page 16).

Further information on opening and closing forces can be found on page 12.



RRFSO Regulatory Reform (Fire Safety) Order 2005

As specifiers seek to meet the DDA duty on behalf of their client they would be well advised to consider the impact of this piece of legislation which became law in October 2006.

Like the DDA, it governs all non-domestic premises and firmly shifts the onus onto the building's owner / occupier; who is usually also the recognised service provider. The legal duty, by which a *responsible person* must take such general fire precautions "as may reasonably be required in the circumstances..." is suitably vague. The penalties for non-conformance are however very clear; the duty invoked is underpinned by criminal law.

So, not only does the initial specification of fire doors and hardware need to be correct but consideration should also be given to the longer term service and maintenance of those products. Clearly a damaged, faulty or worn fire door application not only results in poor fire performance and the risks to life and property which that involves but also poses a possible barrier to access.

To this end, construction project managers are actively seeking out supply chain agreements where the manufacturer, or third party agency, is capable of offering a comprehensive service contract; potentially for the life of the building.

Door controls - Product selection

This flow chart provides a quick guide to the selection of the most appropriate door control for a given application.

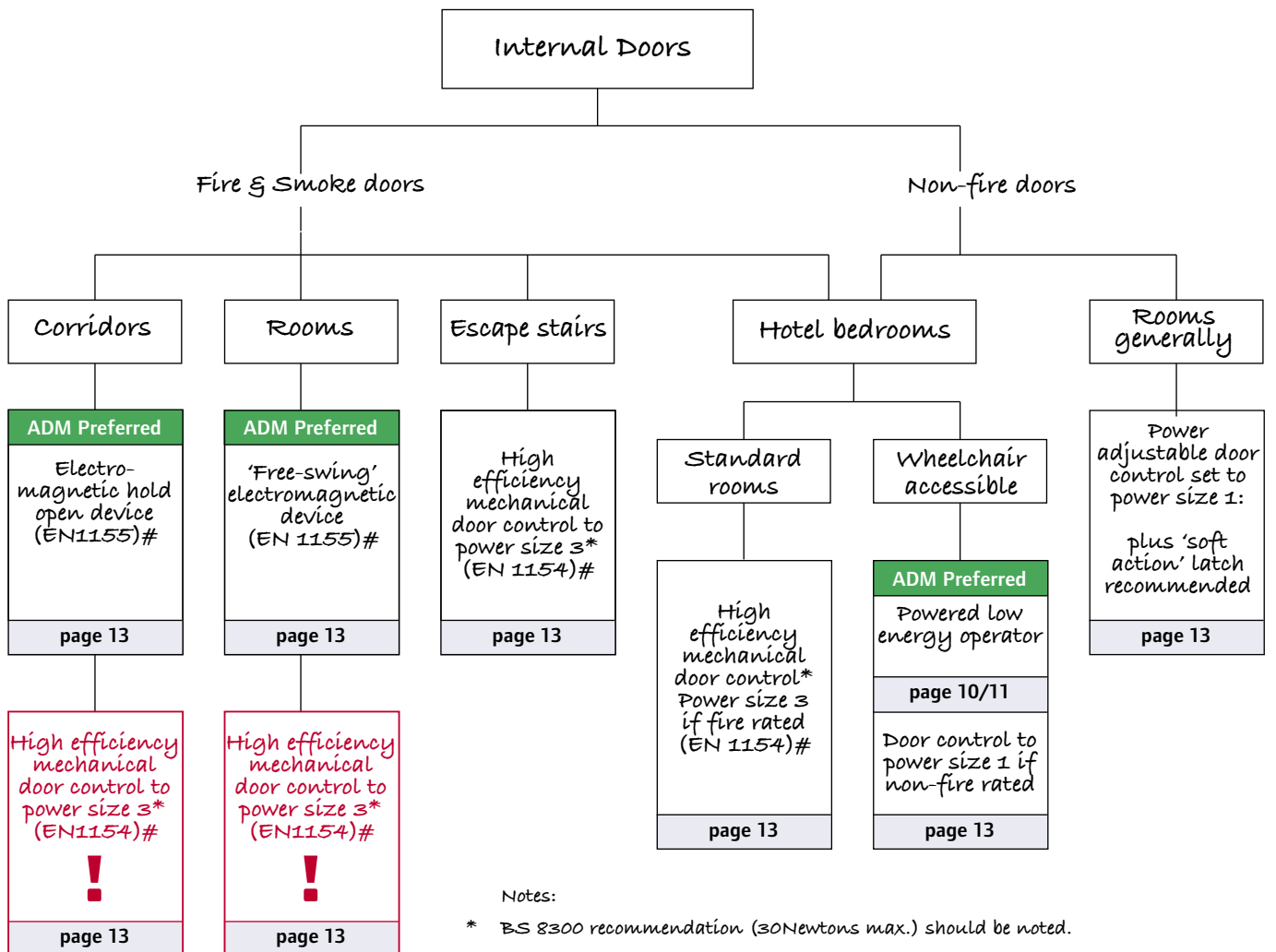
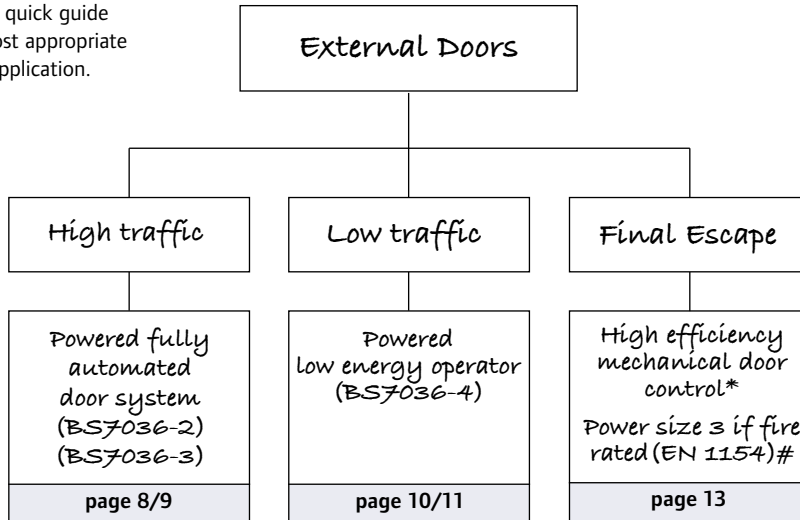

Notes:

* BS 8300 recommendation (30Newtons max.) should be noted.

In addition to these mechanical standards the device must also have relevant fire resistance testing certification (i.e. EN 1634-1)

! All other factors contributing to the final opening force must be considered carefully if this option is selected - refer to page 12

The case for powered doors

As previously indicated, the most inclusive solution to access issues is achieved by a powered door; particularly in the case of external doors which need to be kept closed against wind forces. It may also be the most effective way of achieving the 1000mm effective clear opening width (indicated in Table 2 of ADM 2004) which is intended to be suitable for a variety of users, e.g. parents with children in pushchairs, people carrying shopping, as well as wheelchair users.

ADM – 2.10 states: “A powered door opening and closing system, either manually controlled or automatically operated by sensors, is the most satisfactory solution for most people”

BS 8300 – 6.3.3 states: “Power operated pedestrian doors for installation in existing and new construction, in domestic and non-domestic buildings should be one of the following two types:

- a. a manually operated power operated door controlled by a push pad, coded entry system, card swipe or remote control device; or
- b. an automatic power operated door controlled, e.g. by a motion sensor or a hands-free proximity reader

Note : Power operated pedestrian doors can have a sliding, swinging or folding action.”

Manual controls for power operated pedestrian doors should be located between 750 - 1000 mm from finished floor level (BS 8300 Fig.30). In order to be clearly visible, they should contrast in colour and luminance with the surrounding background; as recommended in Clause 9.1.1

Powered sliding doors

Issues

Automatic sliding doors probably offer the most satisfactory solution for powered entrance doors, provided sufficient space is available to accommodate the full door assembly.

ADM – 2.10 states: “ An automatic sliding door arrangement is particularly beneficial as it avoids the risks associated with automatic swing doors and its use can make it possible to reduce the length of any entrance lobby”

The extent to which the lobby length can be reduced will be determined by the limitations of the motion sensors.

Enhancement options

Reduced Opening

This feature provides the facility to restrict the width of the opening, primarily for energy conservation - i.e. reduced heat loss in winter. Care should be taken that the effective opening width still meets accessibility guidelines.

Panic Breakout

Allows inward-opening or sliding doors to be pushed outwards under emergency conditions where there is no provision to revert to manual operation.

‘Pharmacy’ Operation

A more restrictive version of the *reduced opening* facility. Traditionally used for security purposes where small packages need to be passed through a door gap in out-of-hours situations. Obviously this feature should not be activated in normal use.

Product Selector - Powered Doors



Dor-O-Matic Slide

The Dor-O-Matic Slide is available as a bi-parting or single-slide system (conforming to BS 7036-2), which includes the following standard features:

- Motion detectors
- Threshold safety beams
- Threshold sensors
- Auto-Reverse
- Adjustable opening / closing speed
- Adjustable opening time delay
- Monitored battery pack
- Manual operation in fail mode

Other options include:

- Reduced-opening setting
- Electric locking
- Panic breakout
- *Pharmacy* security function



Dor-O-Matic Scopic

The Dor-O-Matic Scopic is a telescopic sliding door system with four doors, all of which open; thus providing the greatest ratio of door opening width to total door assembly. The Scopic has identical safety and operational features to the Slide.

For full product specification details and case studies, please request Ingersoll Rand Security Technologies' Automated Openings literature.

Powered doors

Powered swing doors

Issues

Automatic swing door operators are a common way of achieving a powered solution and have the added benefit that they can often be fitted to existing doors. As it may not always be obvious that the doors operate automatically, it is essential to ensure that when a person approaches an automatic swing door, they receive some warning of its operation.

The doors need to open well before the person reaches the door and stay open long enough for safe passage. In the event of a power interruption or failure they should either *fail safe* or have a *breakout* facility.

In the case of manually activated powered doors there is a risk that, once operated, the door may start to close as another person is approaching the door. To minimise this risk most high-energy operators include safety features as standard.

ADM – 2.21 states: “Powered entrance doors will satisfy Requirement M1 or M2 if :

- c. when they are swing doors that open towards people approaching the doors, visual and audible warnings are provided to warn people of their automatic operation when both opening and shutting
- e. they revert to manual control or fail safe in the open position in the event of a power failure”

As a rule Low-Energy Operators revert to manual doors, whereas inward opening doors fitted with other types of operators should have a ‘breakout’ facility; allowing the doors to be pushed outwards to facilitate escape in an emergency.

BS 8300 – 6.3.3 states: “Automatic entrance doors that open towards people entering a non-domestic building should incorporate clear text indicating their automatic operation. Proximity sensors should be set so that doors that open towards the flow of pedestrian traffic open early enough, and stay open long enough, to maintain safe entry and exit ”

A safety stop should be incorporated into an automatic entrance door to re-open the door if it starts to close when a person is still passing through. The door should also be capable of manual operation in the event of power failure.

BS 8300 – 6.3.4 states: “A low-energy power operated door operator should be considered for use on swing doors with relatively low levels of pedestrian usage as these doors can either work in manual mode or be set to provide powered opening assistance to users when required, either in *push-and-go* or *power-assist* modes. After a hold-open period, the swing door self-closes in the same way as a conventional door closer.”

Note: The ‘Push-and-Go’ feature activates when the door is pushed beyond 25mm.

Guidance on safe use:

- Low Energy swing doors - BS 7036-4
- Power operated pedestrian swing doors and balanced doors - BS 7036-3
- Straight and curved sliding doors and folding doors - BS 7036-2

Product Selector - Powered Doors



Dor-O-Matic Swing

The Dor-O-Matic Swing and Mid-Swing systems offer the specifier a choice of performance to meet the differing demands of high/low traffic volumes. The Swing version is intended mainly for use on external doors; the Mid-Swing version for internal doors. The units, which can be used for the effective automation of existing doors, include the following standard features:

- Safety stop (Mid-Swing only)
- Power boost close (Swing only)
- Adjustable opening speed
- Adjustable hold-open period
- Full automation - using motion detectors

Other options include:

- Low Energy specification (Mid-Swing only)
- Magnetic locking
- Panic breakout

Revolving doors

The 2004 edition of ADM states that revolving doors are not considered fully accessible.

ADM – 2.20 states: “Revolving doors are not considered accessible. They create particular difficulties, and risk of injury, for people with assistance dogs, people with visual impairment or mobility problems and for parents with children and/or pushchairs. If a revolving door is used, an entrance door complying with 2.17 or 2.21 should be provided immediately adjacent to it and signed to show that it is accessible”

BS 8300 – 6.3.5 states: “Where a power operated revolving door is provided, it should be accompanied by an auxiliary side-hung door conforming to the recommendations of 6.3.2, 6.4.1 and 6.4.2, which is available for use during the whole of the period the building is occupied.

Note: It may be beneficial for the auxiliary door to open automatically.”

Features relating to accessibility

The following features are key to the selection of suitable door controls

- **Low Energy Operators**

Swing-action entrance doors which are required to be fully accessible but are not suited to full automation may be fitted with low-energy operators. These are commonly available as electromechanical devices, although pneumatic operators are also available for specific, demanding applications.

- **Low Kinetic Force**

Low energy operators are designed to open slowly and with low force thus minimising any risk of injury. Due to their low speed, these operators should not be specified on doors with a high traffic flow where motion sensors are to be used as the activation device.

- **Obstacle Detection**

The operator should be capable of detecting any obstruction. As a safety precaution it should stop and try again (known as Auto-Reverse) and if the obstruction is still apparent, close.

Some have a *time-out* function which will close the door if the obstruction is not removed within the specified time.

Product Selector - Low Energy Operators



Briton Quantum low energy operators have the following key accessibility features:

- Adjustable strength
- *Push & Go* action
- Auto-Reverse
- Adjustable delayed action
- Openable beyond 90°
- Fire alarm link
- Door closure in the event of power failure
- Activation by motion sensor
- Power boost latch action
- Conforms to BS 7036-4

These surface mounted operators are easy to install in new or retrofit applications where there is a 230-250v supply.

LCN *Auto-Equaliser* pneumatic systems are available as surface or concealed in-frame variants and are most suited to applications with very heavy doors, strong air pressure differentials or areas where the presence of water, flammable gases or liquids may represent a fire risk.

For product specification details please refer to the Briton Electromagnetic Door Controls and Low Energy Operator literature.

Methods of Operation

Request Button

To facilitate accessibility the operator should be capable of activation via a dedicated push-button - located on the approach to an accessible door. As assisted or automatic opening is not always required by all users, the door operator should also be capable of manual opening / mechanical closing.



'Push & Go'

A site-selectable function which detects the initial pushing action of a user and activates the powered drive mechanism to open the door in a controlled manner.

Motion Sensor

For fully automatic opening in low traffic applications, low energy operators should be capable of being linked to a motion sensor that detects approaching traffic and activates the opening cycle. Correct specification and installation is essential to reduce 'false' activation caused by parallel cross-traffic.

Electronic Access Control (EAC)

In an access control application both the locking device and the operator can be linked to the use of a *token* such as a mag-stripe or proximity card thus providing both accessibility *and* security. The individual user's requirements can be stored on the token to signal, for example, the door to unlock, open automatically, hold open for a pre-determined period, then close and re-lock.



Fail closed

Operators should be capable of being linked to an Automatic Fire Detection system (AFD) which, in the event of an alarm or power failure, allows the operator to close the door mechanically and maintain the door's fire resisting integrity.

Low Energy Operators

Approved Document M:2004 states that adequate provision must be made to enable all people, not only to gain access to a building but also to use the building and its facilities. The Dor-O-Matic WC unit is a direct response to this requirement. We have developed an integrated system which allows the door of an accessible toilet facility to be fully automated. All the components supplied within the package can be applied to a newly constructed doorset or to an existing installation.



The Dor-O-Matic operator can be supplied for inward or outward opening doors as required. Each low energy unit is interfaced with a special internal and external activation pad, a locking unit and an occupancy sensor.

A special external activation pad mounted adjacent to the door incorporates LED indicators to signal the locking status of the door. In green light mode, pushing the pad from outside will trigger the powered operator to open the door.



The internal activation pad also has built-in LED indicators to show the condition of the door. The red light indicates the door is closed and locked and will simultaneously show red on the external pad.

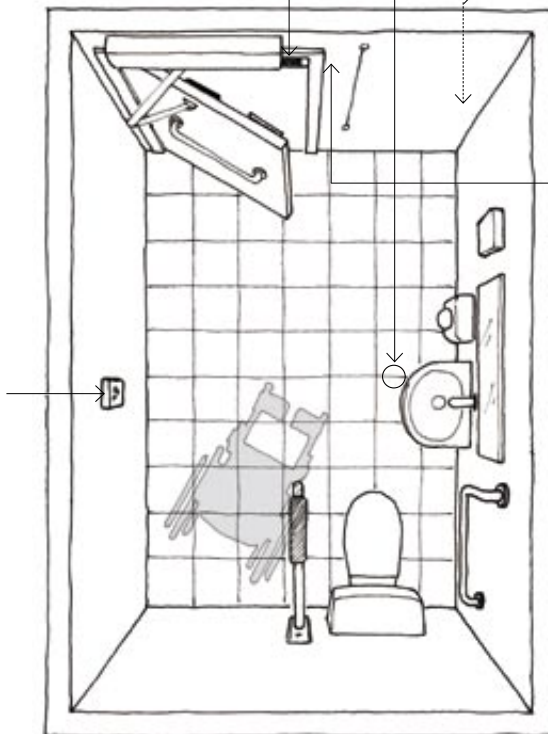

The Dor-O-Matic unit is linked to an electromagnetic lock, surface mounted to the underside of the frame, with the armature mounted on the door face. When the activation pad is pressed from inside, it initiates the system to *close and lock* or *unlock and open*.

Door Status Lights

- **Green Light Condition** - WC is vacant and the door will open if the activation pad is pressed. If nobody enters the room the door will re-close after 90 seconds and revert to Green Light Condition.
- **Red Light Condition** - the door is closed and locked and the outer push pad is rendered inactive. Operating the inner activation pad will unlock and open the door.
- **Yellow Light Condition** - While the door is open the unit goes to Yellow Light Condition. If the light is constant, the door is about to close, lock and enter Red Light Condition.
- ☀ **Flashing Yellow Light Condition** - If the yellow light is flashing it indicates the door is opening or closing and about to enter Green Light Condition.

How it operates

The door is opened, closed, locked and unlocked using the activation pads outside and inside the facility. The LED indicators show the same condition on both pads, working as a set of traffic lights (see left). A sensor detects the presence of someone in the WC. The door will close but not lock if no presence is detected. If a presence is detected the door will stay open until the internal pad is pressed to close and lock the door.



Fixed and hinged support rails with anti-slip grip and good visual contrast are available to complete an installation.

Opening v closing forces

In understanding the issues surrounding door opening and closing forces it is crucial to bear in mind that, for accessibility, we are primarily interested in how easy the door is to open. ADM and BS 8300 therefore stipulate *opening forces*. Conversely, for fire safety we are concerned with the ability to close the door successfully and so EN 1154 quotes *closing moment*. Critical in such considerations is the fact that the two forces are not directly comparable.

Also, *closing moment* is a calculation based on the door width and so the *closing force* measured at the door edge will vary for any particular door application.

For doors which are required to be fire resisting, they must satisfy both the requirements of maximum *opening force* for accessibility and minimum *closing moment* for fire safety.

For doors which are not required to be self closing for the purposes of fire and smoke control, the use of a mechanical door control is determined only by the need to satisfy the maximum *opening force* requirements of BS 8300.

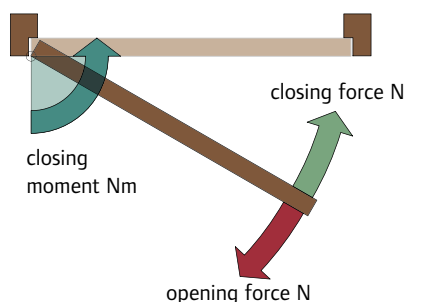

$$\text{closing moment} = \text{closing force} \times \text{door width (m)}$$

Opening forces

BS 8300 Incorporating Amendment No.1 - 7.3.1 states:

"For disabled people to have independent access through single or double swing doors, the opening force, when measured at the leading edge of the door, should not be more than 30N from 0° (the door in the closed position) to 30° open, and not more than 22.5N from 30° to 60° of the opening cycle."

"The ability of a controlled door closing device to close effectively while keeping within the opening force limits depends on its efficiency and the resistances from edge seals, hinge friction, latch resistance and differential air pressure. The opening force should be checked using a plunger type force measuring instrument."

Closing forces

BS 8300 Incorporating Amendment No.1 - 7.3.1 states:

"Door closing devices fitted to hinged (single swing) or pivoted (single or double swing) doors should have 'controlled' action and conform to the requirements of (BS) EN 1154:2001"

This represents a closing moment of 18Nm (Newton Metres) - equivalent to power size 3.

Closer and door efficiency

As we open a door, a mechanical door control momentarily stores the energy we exert and, allowing for some *loss* due to friction in the mechanism, uses the remaining power to close the door. This displaced energy explains why the opening and closing forces **cannot** be identical.

In simple terms

Opening Force x Closer Efficiency % = Closing Force

On this basis, a door closer for a fire door which has to meet the closing requirements of EN 1154 (18Nm closing moment) *and* the initial opening force requirements for accessibility (30N to meet BS 8300) should have an efficiency in excess of 65% (based on a door 900mm wide).

A self closing device that only meets the 55% minimum efficiency required under EN 1154 would therefore not meet the opening requirements of ADM or BS 8300.

The efficiency of the door control, whilst a key factor, is of course not the only consideration facing specifiers. The maximum opening forces stated in BS 8300 are for the *whole door* assembly, in situ. Other factors will affect the actual opening force and steps should be taken to reduce or eliminate these wherever possible.

- Use the highest grade of hinges and seals etc.
- Installation of hardware, door and frame, must be to the highest standards. Factory-fitted performance doorsets are an increasingly viable solution in this regard
- Be especially wary where air pressure differentials are known, or likely, to exist

Ultimately, be prepared to consider alternative solutions if you do not know or cannot control these conditions.

Other issues for accessible openings

In addition to the closer efficiency, the following issues should also be considered.

Adjustable power

In order that door closers can be adjusted to the optimum power consistent with door closing requirements, it is preferable that their power setting is adjustable.

Available to power size 1

Where a door closer is desired but there is no fire protection requirement, adjustability to the lowest power size is essential to help achieve an opening force of 20N or less.

Adjustable delayed action

Delayed action devices are traditionally used as a method to allow extra time for persons to manoeuvre equipment or trolleys through a doorway and should not be regarded as an *accessible* option. Engaging the delay function depends on manual opening, to a wide angle (approx. 85 degrees) and, once the delay time has elapsed, the door may close upon following persons without warning. A possible exception is use on non fire-rated doors to accessible WCs where an adjustable power (Size 1), delay action closer may aid access.

Openable beyond 90°

In order to ensure that the greatest effective opening width is achieved, it is beneficial that the door is capable of being opened beyond 90°.

Non-projecting track arm

Track arm closers are less susceptible to malicious damage.

Mechanical & Electromagnetic door controls

- **Electromagnetic Door Controls**

Electromagnetic (eMAG) hold-open

Doors on circulation routes, particularly fire doors in corridors, need to be fully accessible. The recommended way of achieving this is to install an eMAG hold-open device. This negates any doubts about the suitability of purely mechanical closing devices to meet the dual requirements of closing and opening force limits as set out on page 12.

Various eMAG devices are available to suit single or double action door applications; determining the best solution will depend on individual circumstances.

To comply with European product standard EN 1155, these devices must either be installed with a power interrupt switch in the circuit or have a holding force such that the doors can be manually *pulled off* if required.

Fire authorities recommend a hard-wired connection to an AFD system as this can significantly reduce the spread of lethal smoke within a building. Localised ceiling and product incorporated smoke detectors may not be activated in a timely manner, if at all, under *cold smoke* conditions.

- **Electromagnetic Door Controls (continued)**

Electromagnetic (eMAG) free-swing

This is an alternative solution for doors to *individual spaces* such as offices, kitchens, TV rooms etc. In normal use the door offers no resistance to opening by virtue of the closer spring being electrically *disengaged*. If a fire alarm condition or power interruption occurs, the closer re-engages and closes the door in a controlled manner - regardless of the angle at which it was left.

Integrated devices, incorporating both the holding and closing functions in a single unit, offer the neatest and easiest installation, particularly for new-build projects. Separate holding electromagnets provide an alternative in certain retrofit situations however care should be exercised in their positioning to avoid door twist. There are also limitations as to where they can be sited.

- **Mechanical Door Controls**

High efficiency closers

In situations where a mechanical door closer must be used, the use of high efficiency door closers is essential in meeting the opening and closing force limits for either fire door applications or non-fire door applications.

Briton overhead door closers with variable power, including the Briton 2003V, have *wind-thru* power adjustment from power size 1. This allows them to be fine tuned to help meet the demands of the opening and closing force requirements and the prevailing site conditions.

Product Selector - eMAG Door Controls



Briton 2130B.TE



Briton 996

Feature	product ref	
	996	2130B.TE
'Integrated' device	•	•
Adjustable power or fixed power	fixed	adjustable
Openable beyond 90°	•	•
eMAG hold-open	•	•
Selectable free-swing action	•	-
Manual release of hold-open	•	•
Closes on power failure/alarm activation	•	•
Coloured finishes to match Normbau	-	•
Metallic finishes	•	•
CE marked	•	•

Product Selector - Mechanical Door Controls

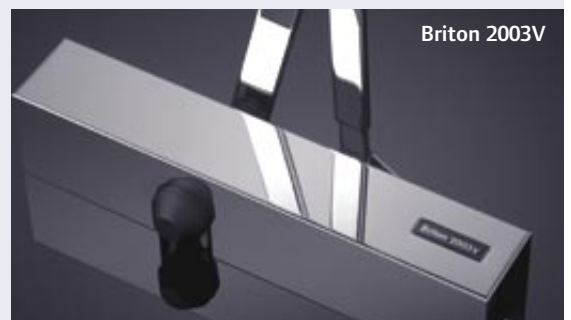

Briton 2003V

Feature	series ref		
	2003V	2100	4040
Adjustable power	•	•	•
Power size 1 available	•	•	•
Adjustable delayed action option	-	-	•
Adjustable backcheck	•	•	•
Openable beyond 90°	•	•	•
Coloured finishes to match Normbau	•	•	•
Metallic finishes	•	•	•
CE marked	•	•	•

Main issues for accessibility

The main issues for lever and pull handles in relation to accessibility are:

- the ability to grip and operate the door opening furniture
- the need to avoid clothing being caught
- the need for *visual contrast*
- avoiding cold, external tactile surfaces

Grip and convenient operation

This issue relates to the shape and diameter of the lever or pull handle and its spacing from the face of the door.

ADM does not detail the dimensions or shape of door opening furniture.

BS 8300 (Figure 17) however, indicates that a circular section lever handle should be at least 19mm dia. and the spacing from the face of the door should be no less than 45mm. There is a clear preference, both in ADM and BS 8300, for lever handles rather than knob furniture.

Some applications, mental health and penal institutions for example, may demand specially designed *anti-ligature* or *anti-barricade* knobs. In such exceptional circumstances it is reasonable to assume that the risks associated with self harm take precedence over access concerns. This is a good example of an access statement being used to note a reasoned departure from accepted guidance.

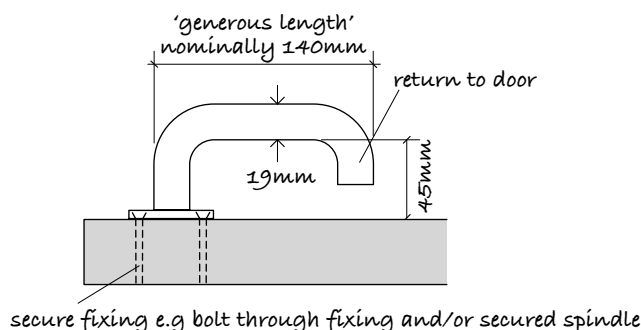

ADM – 2.17 states “Manually-operated non-powered entrance doors will satisfy Requirement M1 or M2 if :

- c. where fitted with a latch, the door opening furniture can be operated with one hand using a closed fist, e.g. a lever handle”

BS 8300 – 6.5.1 Door opening furniture states: “Wherever possible, door opening furniture with a lever action should be used, as door furniture with a spherical, circular or similar design is difficult to use by people with, for instance, arthritis or a weak grip.

It should be possible to operate door opening furniture one handed, without tightly grasping it or twisting the wrist, e.g. by using a closed fist”

BS 8300 also recommends that the end of the lever is returned towards the face of the door. This avoids loose clothing being caught and aids grip, in that it helps prevent the user’s hand slipping from the lever. This is particularly important as many elderly, infirm or disabled persons use the lever handle to support themselves.

Although BS 8300 only provides the term *generous length* for lever handles, best practice derived from ergonomic studies suggests an internal dimension of approximately 100mm.

The need for visual contrast

The definition stated in ADM (0.29) is based on original guidance from The Department for Transport.

It advises that visual contrast is satisfactory where there is a difference of at least 30 points in Light Reflectance Values on an absolute scale of 0-100.

BS 8300 references newer research which charts *zones* of good, acceptable or poor levels of visual contrast. These are detailed in Annex G of Amendment No.1, with the comment: “Whilst there is considerable confidence in recommending a difference in LRV of 30 points or more (the good zone), there is also much anecdotal evidence to suggest that a difference of around 20 points may still be acceptable.” This 20 point figure was subsequently acknowledged by ODPM as an *acceptable alternative* to the guidance given in ADM.

ADM – 2.17 states: “Manually-operated non-powered entrance doors will satisfy Requirement M1 or M2 if :

- d. all door opening furniture contrasts visually with the surface of the door

BS 8300 – 6.5.1 Door opening furniture is virtually identical to the ADM quote, stating: “For easy identification by visually impaired people all door furniture should contrast visually with the surface of the door.”

Light Reflectance Value (LRV)

LRV is a measure of *brightness* or *luminance*. It is a measure of the total amount of light reflected from a surface. For example, a black surface will absorb most of the light falling on it, giving an LRV of less than 10. A white surface will reflect most of the light falling on it so it will have a correspondingly high figure, typically near 90. In between these extremes fall the LRVs of coloured surfaces.

A person with a visual disability may well have difficulty in identifying the colour accurately but will be able to perceive some light being reflected from the surface.

Actual perception i.e. the ability to locate door opening furniture on a door face - as distinct from pure laboratory studies - is a subject for much discussion. The practices employed by people with impaired vision in the context of approaching a door are also a consideration. The Research Group for Inclusive Environments (RGIE) was commissioned to undertake further research specifically related to this area. The project, in association with the Guild of Architectural Ironmongers, was completed in 2005. The results indicated that a visual contrast of 20 points was sufficient for the majority of users to distinguish between the elements i.e. the door and a handle.

Door operating furniture

Research study

Independent research conducted by Sheffield Hallam University has identified combinations of finishes for door operating furniture and door surfaces which either meet, or do not meet, the original 30 point criterion.

The researchers used a spectrophotometer to measure the LRV of all Normbau colour and Briton metallic finishes against a wide range of coloured laminate and wood veneer door surfaces.

The results showed:

Coloured handles with high light reflectance values - White, Ivory and Yellow - contrast well with darker laminated door facings.

Conversely, those with low light reflectance - Dark Grey, Green, Red, Blue, Brown, Dark Green, Dark Red, Dark Blue and Black - contrast well with lighter laminated door facings.

Light coloured wooden veneers - such as Ash crown cut, Koto, white Beech and Maple crown cut - only reflect around half the light falling on them. Nevertheless, when used with the darker coloured lever handles, an acceptable LRV difference is achieved.

Darker coloured wooden veneers offer less choice. Red oak crown cut, steamed Beech, Cherry crown cut, American white oak crown cut and Sapele provide sufficient contrast only when partnered by White and Ivory nylon handles.

Metal handles present a more complex argument when the range of available surface finishes is considered. Relative contrast is susceptible to change according to external factors such as the level of ambient and/or cast light. Fading or darkening of wood veneers may, over time, add further variance.

Research study continued

No product is *good* or *bad* in its own right. The critical factor for consideration is the combination of elements and the circumstances of the application.

To assist specifiers in achieving the required level of visual contrast, Ingersoll Rand Security Technologies has compiled a matrix which sets the measured LRVs of actual products against a variety of indicative veneers and laminate surfaces.

‘Coldness to the touch’

In the depths of winter, a bare metal surface can become extremely cold to the touch. While most people merely experience discomfort, for some, such as those prone to *Raynaud’s Phenomenon*, the effect can be painful.

For this reason both ADM and BS 8300 refer to the desirability of external door opening furniture and handrails being “not cold to the touch”. BS 8300 further suggests that materials with a low thermal conductivity such as wood or nylon might be suitable finishes.

ADM – 2.17 states: “Manually-operated non-powered entrance doors will satisfy Requirement M1 or M2 if:

- d. all door opening furniture contrasts visually with the surface of the door and is not cold to the touch “

BS 8300 – 6.5.1. states: "Preferably, external handles on entrance doors should not be cold to the touch."

Whilst it is prudent to avoid bare metal externally, astute designers will realise that greater emphasis on the use of powered door openings will often negate the need to touch door opening furniture.

Product Selector - Door Opening Furniture

Ingersoll Rand Security Technologies recommends using door opening hardware from the Normbau range, with the colour being chosen according to the light reflectance characteristics of the door surface.

The table below illustrates each range’s ability to meet all the guidance in ADM and BS 8300.

* A - Bolt through rose fixing B - Spindle fixing C - Bolt through rose & spindle fixing

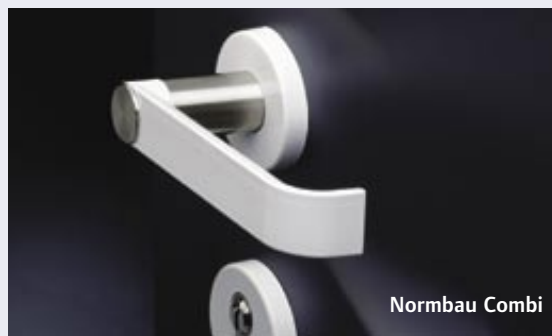

Product Range	Briton Specification Series	Normbau Combi Line	Normbau Nylon Line
Lever fixing method (*see codes above)	C	A	A/B/C
Safety lever design	•	•	•
Lever dimensions meets minimum requirements of BS 8300	•	•	•
Finishes available	Stainless Steel	12 colours	12 colours
‘Not cold to the touch’ (external applications)		•	•
EN 1906 Compliant	•	•	•

Main issues for accessibility

The main issues for lock and latch cases in relation to accessibility are:

- the minimum distance from the door edge to the centre of the keyway – known as *backset*
- the distance between the handle follower and the centre of the keyway – known as *lock centres*

Although ADM does not specifically address latch and lock cases, BS 8300 (Figure 17) states a minimum backset of 54mm. BS 8300 also gives the following recommendations on lock centres.

BS 8300 – 6.5.3.2 - Locks and latches states: “Lever handles should be used wherever possible in conjunction with an upright mortice lock / latch.”

“To ensure that people with impaired vision and/or dexterity have unobstructed access to the keyway, the cylinder should either be above the lever handle or the minimum distance between the handle and the keyway of the locking mechanism should be 72 mm.”

By meeting these minimum dimensions accessibility is improved. Greater space is created, both around the operational parts of the lock and between these parts and the door frame when the door is closed. This allows better key access and easier operation, especially for those with limited manual dexterity.



Normbau Nylon

Normbau Nylon Line is a range of door furniture that is available in a variety of styles and sizes. It can be supplied either complete with roses or backplates, or separately. Levers can be supplied in solid nylon or steel cored nylon for extra strength. The end of the lever is returned towards the door face.

Normbau Combi Line is a new addition to the Normbau range. Combining aesthetic, high quality stainless steel elements with the durability of nylon provides long-lasting products with anti-corrosive and fade resistant properties.

Briton Specification Series is a range of stainless steel door furniture designed around the dimensional recommendations of BS 8300.

In addition to meeting all the recommendations on accessibility, these products also comply with the latest mechanical performance standards contained in EN 1906.

Product Selector - Lock Operation



Briton 5500 Series Cylinder Locks

Lock Centres	72mm
Backset	60mm
Latch torque*	2Nm
Latch action**	3.5N
Bolt throw	22mm single throw
EN 12 209 compliant	•

* Torque needed to retract the latch by the use of a lever handle. A low torque provides an easy to operate lockset

** Force needed to depress the latch. A low force helps positive location into the frame when size 1 closers are specified. Often referred to as a *soft action* latch

The following lock functions are available in the range:

- 5510 – cylinder deadlock
- 5520 – cylinder sashlock
- 5530 – cylinder bathroom lock
- 5540 – cylinder latch
- 5550 – cylinder nightlatch
- 5560 – cylinder escape lock

For product specification details please refer to the Briton Product Literature.

Electronic Access Control (EAC)

Although traditionally associated with security applications, EAC technology holds many advantages and benefits that can play a significant role in access provision. The application of proximity card readers for example, can significantly improve accessibility for many users with disabilities.

Often the ideal solution to a specific access problem is not available by using mechanical products alone. With EAC many different products can be adapted and/or used in conjunction to provide safe, secure *and* accessible solutions.

Final Exit hardware

General considerations

The legislation referenced in this guide is primarily concerned with access and not egress; however specifiers will obviously need to consider certain key principles. There is limited guidance on exit doors within BS8300 and nothing is included in ADM (Means of Escape is dealt with in Approved Document B - Fire Safety). Also, the wholesale reorganisation of fire precautions legislation under the RRF50 (page 6) focuses attention on the correct selection, and maintenance, of fire life-safety products.

All panic and emergency exit devices supplied for use in the UK have been required to conform to the relevant European standards - and carry the CE mark as proof of conformity - since April 2003.

Primary applications

Escape hardware applications fall under two main categories:

- Exit doors on an escape route in a public building (or section of a building to which the public may reasonably have access) such as a theatre, leisure centre, hospital etc
- Emergency exit doors in a low occupancy environment, which are used by people who have prior knowledge of their operation

Escape route exit doors in public buildings

The most common types of bar operation for this application are the traditional pivoting pushbar device and the modern chassis touchbar device. The decision usually being dictated by functional or aesthetic considerations, such as the door detail or the buildings' period styling.

Many locking permutations are available, including single, double or multiple locking points using rim or mortice latches or vertical rods with bolt heads or Pullman latches. This offers a choice of visual appearance and security level to meet the demands of the building's users.

These dedicated exit devices are covered by European standard EN 1125 which requires "safe and effective escape through the doorway with minimum effort and without any prior knowledge of operation."

The option of a visually contrasting finish should be considered for areas which may be accessed by persons with a visual impairment.

As mentioned, BS8300 does not cover escape hardware in detail but does provide the following general guidance:

BS 8300 - 6.5.1 - Door opening furniture states: "Care should be taken in the selection of security and fire exit fittings..... with the aim of making them manageable for all users."

Emergency exit doors with 'prior knowledge'

Smaller premises, or certain areas in larger buildings where the public have no rights of access, are often specified with exit devices operated by a pad or lever handle.

These devices must conform to European standard EN 179 and users should receive training in their operation to satisfy both fire life-safety legislation and the access in employment provisions of the DDA Part II.

Product Selector - Panic Exit Hardware



Briton 376E is a robust range consisting of a vertical panic bolt, a rim panic latch and a mortice latch operator.



Briton 560 pushbar and 570 touchbar ranges of modular panic exit devices are designed for the mid to high-end specification market and provide single, double or multi point locking for single or double door configurations.



Briton 389E-N Pad operated mortice nightlatch.

Also available as:

Briton 372E - push pad vertical bolt

Briton 1438E - push pad rim latch

All these panic hardware ranges meet the latest European standards and are available in coloured finishes to match the Normbau range of colours.

Full details of the above products are available in individual brochures for the Briton 376E and 560 / 570 Series ranges.

For further information..

.... tear off and complete the reverse of this reply paid card, fold in half and post back to us.



Business Reply
Licence Number
RRBU-ZYLT-SHTZ

2

Ingersoll Rand Security Technologies

Marketing Department
Bescot Crescent
Walsall
WS1 4DL

Useful contacts & acknowledgements

BSI
British Standards Institute
389 Chiswick High Road
London W4 4AL
Tel: 020 8996 9001

CAE
Centre for Accessible Environments
70 South Lambeth Road
London SW8 1RL
www.cae.org.uk
020 7840 0125

CLG
Communities and Local Government
Eland House
Bressenden Place
London SW1E 5DU
www.communities.gov.uk
020 7944 4400

DRC
Disability Rights Commission
DRC Helpline
Freepost MID 02164
Stratford Upon Avon CV37 9BR
www.drc.org.uk
08457 622633

GAI
Guild of Architectural Ironmongers
8 Stepney Green
London E1 3JU
www.gai.org.uk
020 7790 3431

NRAC
National Register of Access Consultants
70 South Lambeth Road
London SW8 1RL
www.nrac.org.uk
020 7735 7845

RGIE
Research Group for Inclusive Environments
PO Box 217
The University of Reading
Reading RG6 6AW
www.extra.rdg.ac.uk/ie
0118 378 6734

RIBA
Royal Institute of British Architects
66 Portland Place
London W1B 1AD
Tel: 020 7580 5533

Ingersoll Rand Security Technologies are pleased to assist with any queries. General enquiries should be directed to our main office or Customer Care Centre; technical queries to our Technical Services Department – refer to back cover for contact details. Our Marketing department can organise RIBA approved CPD Seminars based on the contents of this guide.

All covers and extracts from Approved Document M are reproduced by kind permission of HMSO.

Permission to reproduce extracts from BS 8300:2001 is granted by BSI. British Standards can be obtained from:
BSI Customer Services
389 Chiswick High Road
London W4 4AL.
Tel: +44 (0)20 8996 9001.
email: cservices@bsi-global.com

For further information..

Complete this reply paid card, moisten the edges and fold together.

Please send information to...

Name:	
Company:	
Address:	
Post Code:	
Tel:	
Fax:	
email:	

moisten the edges and fold together along here

Further information required

<p>Please tick as appropriate</p> <p><input type="checkbox"/> Please arrange for a technical representative to visit me</p> <p><input type="checkbox"/> Please contact me to arrange a DDA openings audit</p> <p><input type="checkbox"/> Please contact me to arrange a DDA CPD Seminar</p>	<p>Please send information on the following</p> <p><input type="checkbox"/> Automated Openings</p> <p><input type="checkbox"/> Performance doorsets</p> <p><input type="checkbox"/> Overhead door controls and Low Energy operators</p> <p><input type="checkbox"/> Electromagnetic door controls</p> <p><input type="checkbox"/> Briton Specification Series hardware</p> <p><input type="checkbox"/> Normbau nylon door hardware</p> <p><input type="checkbox"/> Entrance pull handles</p> <p><input type="checkbox"/> Anti-ligature products</p> <p><input type="checkbox"/> Locks</p> <p><input type="checkbox"/> Exit devices</p> <p><input type="checkbox"/> Service & Maintenance</p>
--	--



Ingersoll Rand's Security Technologies Sector is a leading global provider of products and services that make environments safe, secure and productive. The Sector's market-leading products include electronic and biometric access control systems; time and attendance and personnel scheduling systems; mechanical locks and portable security, door closers and exit devices, steel doors and frames, architectural hardware and technologies and services for global security markets.

Ingersoll Rand Security Technologies

Bescot Crescent Walsall West Midlands WS1 4DL

Tel. 01922 707400 Fax. 01922 651965 Customer Care Centre Tel. 08706 012012 Customer Care Centre Fax. 0800 834103

Email info@ingersollrand.co.uk **Web** www.securitytechnologies.ingersollrand.co.uk